

		Use with		
X-BT-MR M6/14 SN 8	TX-BT 4.7/7 80	DX 351-BT	X-BT 1/4" - 20Nm/14,8 ft lb	X-NSD 1/4"-10 mm
X-BT-MR W6/14 SN 8	TX-BT 4.7/7 80	DX 351-BT		X-NSD 1/4"-7/16"

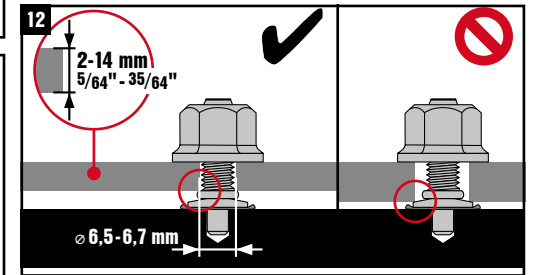
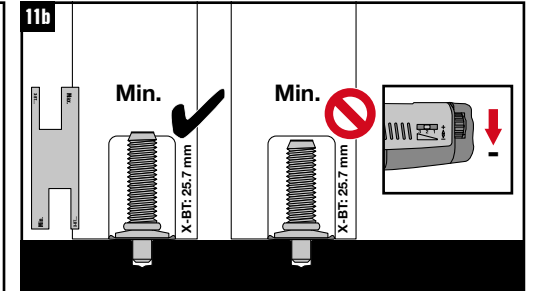
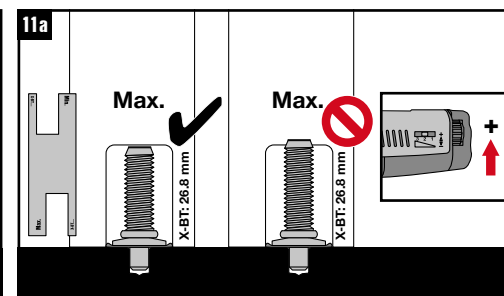
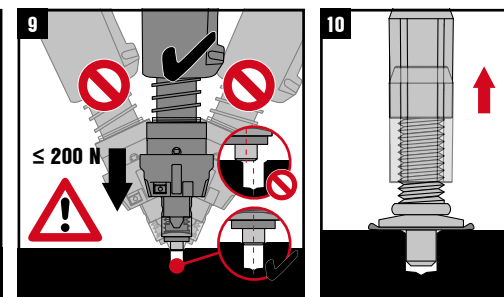
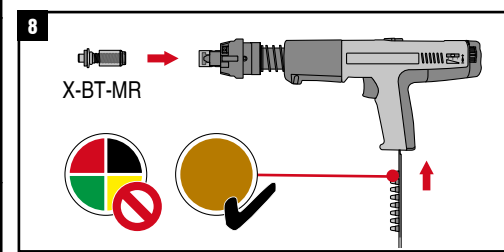
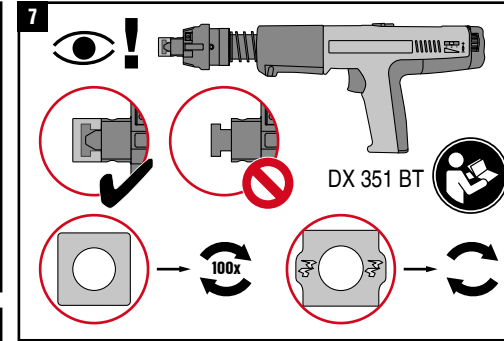
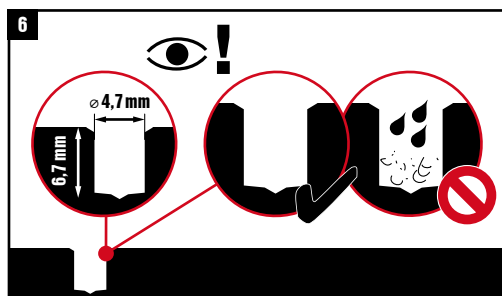
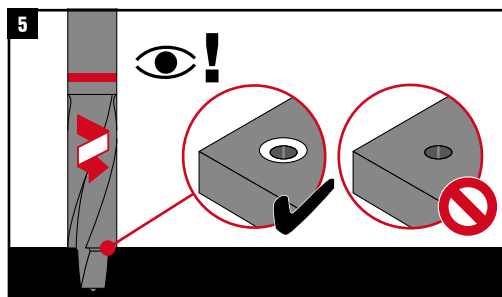
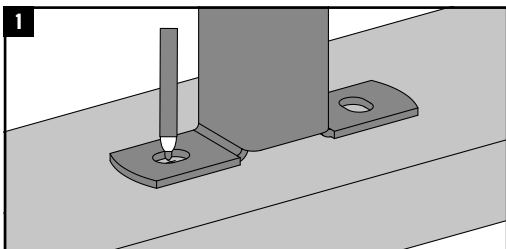
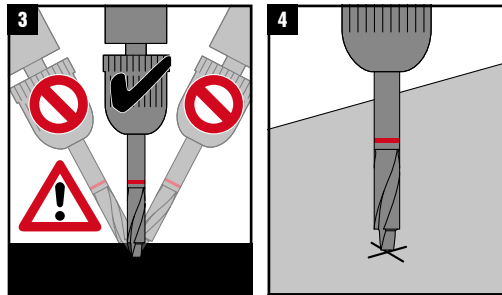
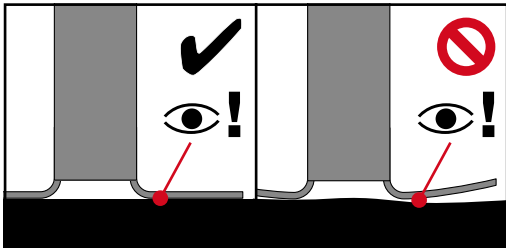

13B

SF 14-A	3	15
SF 10W/ BM-A22	4	15
SFC 14/22-A	2	15

13C

≤ 20 Nm
14.8 lb-ft

T_{inst}

